

WELKOM  
BIENVENUE

# UITNODIGING

50 JAAR TRACTOREN IN ANTWERPEN



Naar aanleiding van 50 jaar tractoren in Antwerpen en de voorstelling van de Fantastic Farmer Days, nodigen we u vriendelijk uit op dinsdag 22 april in onze New Holland fabriek te Antwerpen.



Gelieve uw aanwezigheid te bevestigen vóór 15 april a.s. per email aan [lode.vandevyvere@newholland.com](mailto:lode.vandevyvere@newholland.com)



**11u00**

Ontvangst in de gebouwen van  
New Holland Tractor Limited NV  
Wilmarsdonksteenweg 32, 2030 Antwerpen

**11u30**

Doel en planning van de  
Benelux Fantastic Farmer Days

**12u30**

Lunch

**13u00**

Academische zitting

**13u40**

Bedrijfs rondleiding  
Toespraak door Monica De Coninck, minister van Werk

**15u00**

Agriculture Experience

**15u45**

Receptie

**17u00**

Einde

# Fantastic Farmer Days: De melkveehouder van morgen





# Fantastic Farmer Days

BENELUX

Lode Vande Vyvere  
Marketing Manager

Contains confidential proprietary and trade secrets information of CNH Industrial. Any use of this work without express written consent is strictly prohibited.



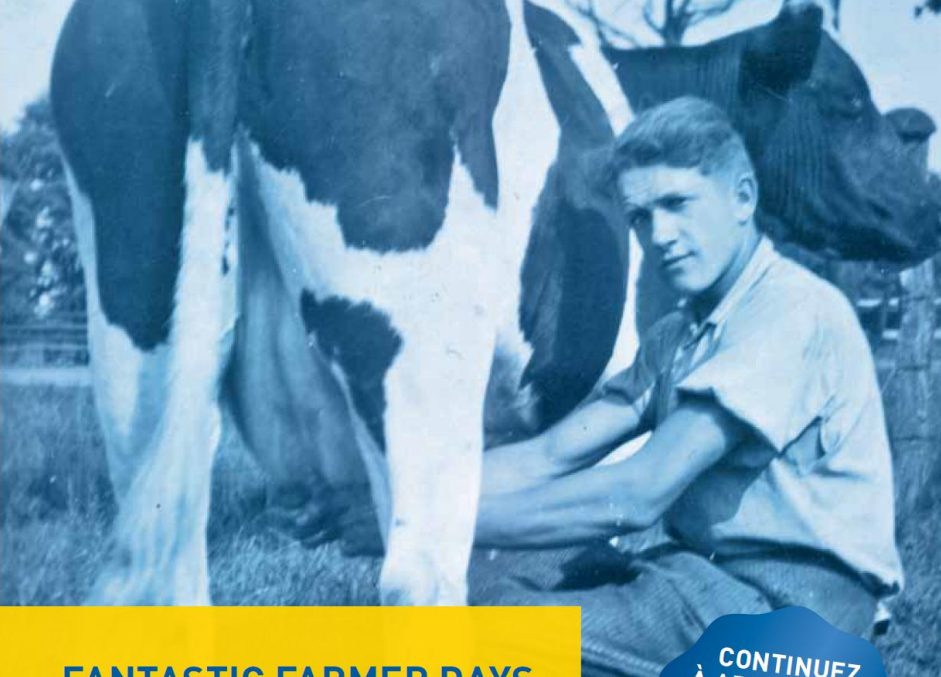

## FANTASTIC FARMER DAYS

VENEZ DÉCOUVRIR LES NOUVELLES TECHNOLOGIES ET SOLUTIONS POUR LES PRODUCTEURS LAITIERS. INSCRIVEZ-VOUS DÈS MAINTENANT SUR [WWW.FANTASTICFARMERDAYS.BE/FR](http://WWW.FANTASTICFARMERDAYS.BE/FR) ET PROFITEZ D'UN BBQ GRATUIT ET D'UNE SURPRISE.

**CONTINUEZ À APPRENDRE !**

Venez aux Fantastic Farmer Days !

[WWW.FANTASTICFARMERDAYS.BE/FR](http://WWW.FANTASTICFARMERDAYS.BE/FR)

Indiquez sur le site l'élevage laitier dans lequel vous souhaitez vous rendre

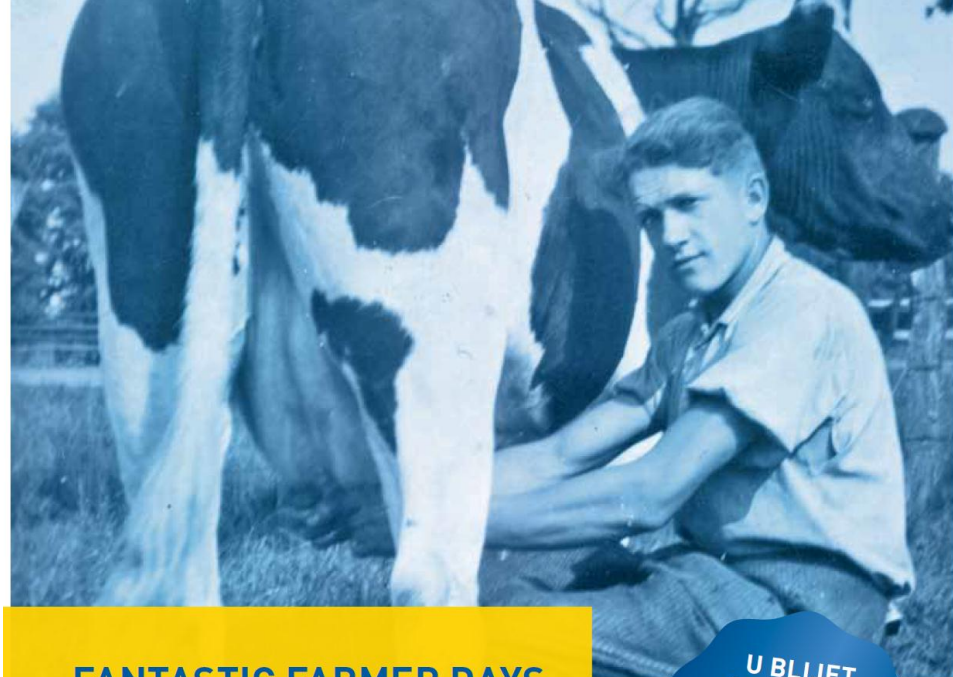

## FANTASTIC FARMER DAYS

KOM EN ONTDEK NIEUWE TECHNOLOGIEËN EN OPLOSSINGEN VOOR DE MELKVEEHOUDER. REGISTREER U NU OP [WWW.FANTASTICFARMERDAYS.BE](http://WWW.FANTASTICFARMERDAYS.BE) EN GENIET VAN EEN GRATIS BBQ EN VERRASSING!

**U BLIJFT GRAAG BIJ?**

MIS DEZE FANTASTIC FARMER DAYS NIET!

[WWW.FANTASTICFARMERDAYS.BE](http://WWW.FANTASTICFARMERDAYS.BE)

duid op de website aan bij welk toonaangevend melkveebedrijf u te gast wilt zijn in uw regio

OEDELEM 26 MAI - ZAFFELARE 28 MAI - WUUSTWEZEL 2 JUNI - BIESME 4 JUNI - DELLEN 6 JUNI - REUSEL 17 JUNI  
MONTFOORT 19 JUNI - VEGELINSOORD 21 JUNI - ELP 23 JUNI - DOETINCHEM 25 JUNI

OEDELEM 26 MEI - ZAFFELARE 28 MEI - WUUSTWEZEL 2 JUNI - BIESME 4 JUNI - DELLEN 6 JUNI - REUSEL 17 JUNI  
MONTFOORT 19 JUNI - VEGELINSOORD 21 JUNI - ELP 23 JUNI - DOETINCHEM 25 JUNI

### LE PROGRAMME FANTASTIC FARMER DAYS DURE DE 10 À 15H :

- Soyez l'hôte d'une exploitation laitière Delaval de référence dans votre région, où vous pourrez voir fonctionner la machine à traire et recevoir des conseils.
- Différents ateliers vous apprendront tout ce que vous voulez savoir sur un investissement dans un nouveau tracteur :
  - Explications sur les tracteurs New Holland de toutes classes de CV
  - Systèmes GPS pour exploitations laitières
  - Pneus Mitas
  - Chargeurs frontaux Stoll
  - Les différentes possibilités de financement de CNHiCapital
- Des intervenants de premier plan du secteur laitier ne manqueront pas de vous donner de nouvelles idées et de l'inspiration :
  - Quelles menaces planeront sur l'exploitation laitière au cours des prochaines années, et comment les transformer en opportunités ?
  - Quelles sont les paramètres limitatifs de l'exploitation laitière ?
  - Producteur laitier, connaissez votre prix critique du lait !
  - Que va changer le nouveau permis environnemental et comment pourra-t-atteindre les objectifs de préservation ?
  - Comment un producteur laitier peut-il gérer ses risques et ses prix de revient dans une perspective d'avenir ?

### FANTASTIC FARMER DAYS PROGRAMMA DUURT VAN 10U T/M 15U:

- Te gast op een toonaangevend melkveebedrijf uit uw regio waar u de melkmachine van Delaval in actie ziet en geadviseerd wordt.
- Op de diverse workshops maakt u kennis met alles wat u wenst te weten over de investering van een nieuwe tractor:
  - Uitleg over de New Holland tractoren in alle pk klassen
  - GPS systemen voor de melkveehouder
  - Mitas banden
  - Stoll voortladers
  - Diverse financieringsmogelijkheden van CNH Capital
- Eminente spreker in de melkveesector bezorgt u ongetwijfeld nieuwe ideeën en inspiratie:
  - Welke bedreigingen staan de melkveehouder te wachten in de komende jaren en hoe buig je die om in kansen?
  - Wat zijn de limiterende parameters in de melkveehouderij?
  - Melkveehouder, ken uw kritische melkprijs !
  - Wat mogen we verwachten van de nieuwe omgevingsvergunning en hoe zullen de instandhoudingsdoelstellingen ingevuld worden?
  - Hoe doe je als melkveehouder aan risicomanagement en kostprijsbeheersing op een toekomstgerichte manier?



# Wat zijn de Fantastic Farmer Days?

---

- 10 infodagen die bij en voor de melkveehouder georganiseerd worden.
  - 5 in Belux
  - 5 in Nederland
- De melkveehouder kan zich enkel vrijmaken tussen 9u. en 16u.
  - Demonstraties en beurzen zijn hierdoor moeilijk toegankelijk.
  - Fantastic Farmer Days:
    - ✓ Aanvang om 10u.
    - ✓ Einde om 15u.
  - Mogelijk voor iedere melkveehouder om er aanwezig te zijn .



# Wat is het doel van de Fantastic Farmer Days?

---

- Alle melkveehouders uit de Benelux bereiken en hen een brede waaier aan informatie meegeven over:
  - Alle nieuwe tractoren, voorladers en GPS systemen voor de veehouder
  - Verreikers en persen
  - Banden: de juiste keuze maken in het brede aanbod
  - Melkmachines
    - ✓ Hoe kunnen we efficiënter melken
    - ✓ Melkmachines in werking
    - ✓ Laat u adviseren
  - Het post melkquotum tijdperk
    - ✓ Bedreigingen en opportuniteiten
    - ✓ Hoe doe je aan risicomangement en kostprijsberekening op een toekomstgerichte manier
    - ✓ Ken je kritische melkprijs
  - Financieringsadvies

# Waar en wanneer gaan de Fantastic Farmer Days door?

Event	Plaats	Land
maandag 26 mei	Oedelem	België
woensdag 28 mei	Zaffelare (Lochristi)	België
maandag 2 juni	Wuustwezel	België
mercredi 4 juin	Biesme	België
vendredi 6 juin	Dellen	GH Luxemburg
dinsdag 17 juni	Elp	Nederland
donderdag 19 juni	Doetinchem	Nederland
zaterdag 21 juni	Vegelinsoord	Nederland
maandag 23 juni	Montfoort	Nederland
woensdag 25 juni	Reusel	Nederland



# Agenda Fantastic Farmer Day

---

- 10.00u: Aankomst  
Check-in, koffie
- 10.30u: Verwelkoming  
Voorstelling van alle partners, orde van de dag
- 10.45u: Dynamische presentatie van alle producten voor de tribune
- 12.00u: BBQ en dessert  
Rodeo challenge
- 13.00u: Workshops van telkens 20min.  
Iedereen kan aan 6 workshops deelnemen
- 15.00u: Koffie en gebak  
Verrassing
- 16.00u: Einde voorzien



# Te gast bij de melkveehouder



# Locaties









# Fantastic Farmer Days

BENELUX

Ludo Bols  
Commercieel directeur Delaval

Contains confidential proprietary and trade secrets information of CNH Industrial. Any use of this work without express written consent is strictly prohibited.





# DeLaval Fantastic Farmer Days





# DeLaval is a part of Tetra Laval

## Tetra Laval

Tetra Pak

DeLaval

Sidel

From Farmer to consumer

Milk  
production

Food  
preparation

Food  
processing

Food  
packaging

Food  
distribution

# DeLaval Fantastic Farmer Days

## De BE melkveehouder zit in groeipeloton binnen Europa

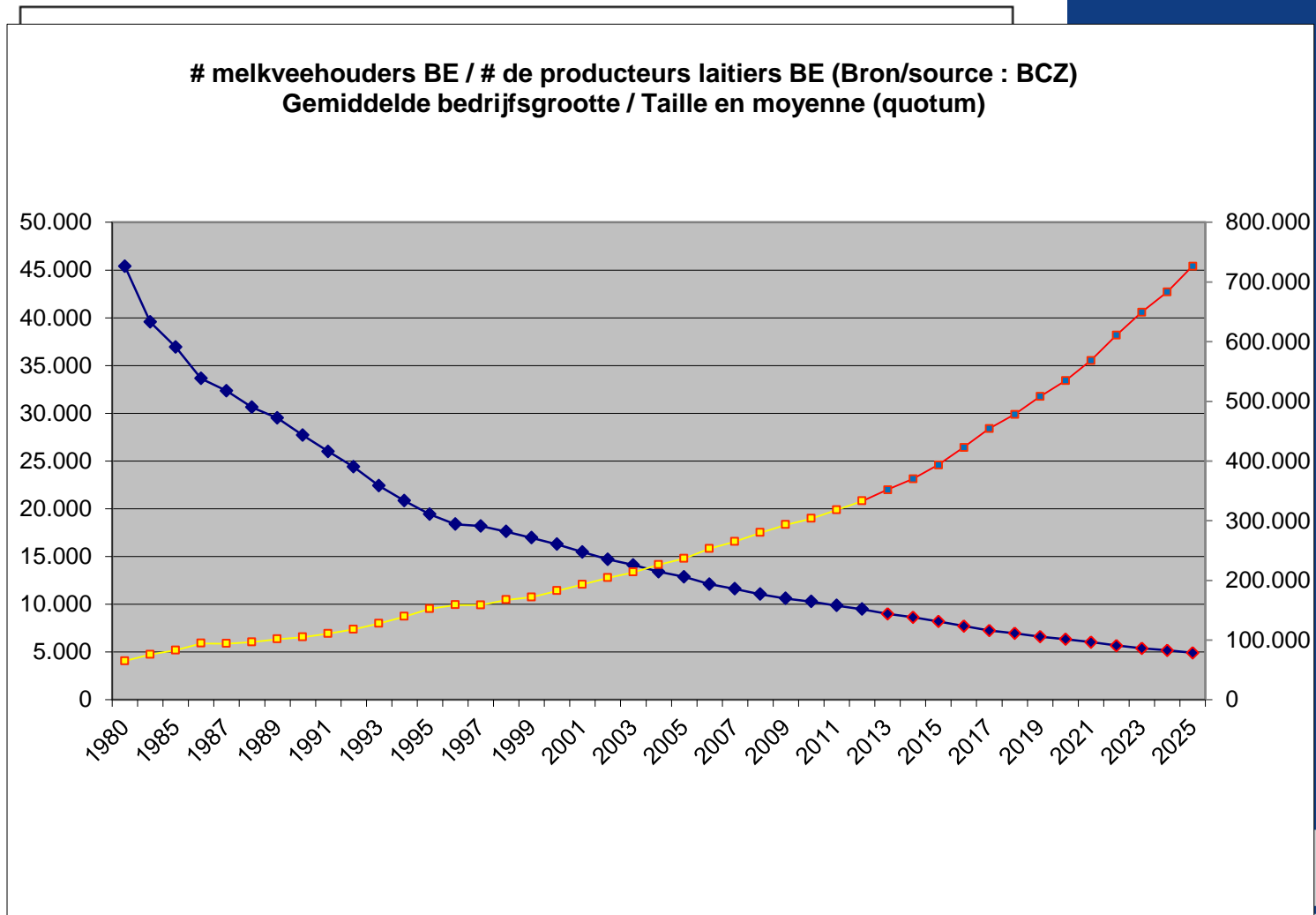

# DeLaval Fantastic Farmer Days

*Naast de vraag hoe u wilt gaan melken,  
staat vooral “hoe u uw groeiende  
melkveebedrijf wil gaan managen”  
centraal!*

# DeLaval Fantastic Farmer Days

Hoe gaat u, beste melkveehouder, uw bedrijf managen ?

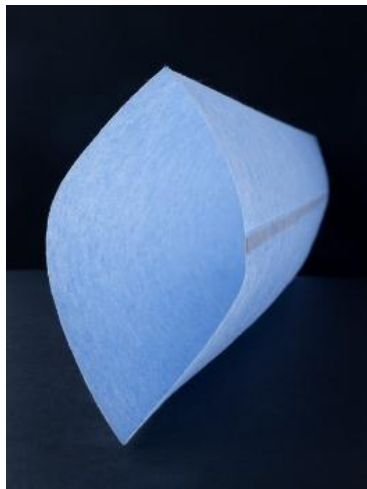

Attentiewaarde  
verhogen

Individuele  
data  
genereren

Gekoppelde  
data gebruiken  
van verschillende  
systemen /  
sensoren

Alles in één  
analyse met  
proactief  
management



*Eenvoudig*

*Geavanceerd*



# DeLaval Fantastic Farmer Days

## DELPRO™ FARM MANAGER

FARM MANAGEMENT AS  
IT SHOULD BE

BECAUSE YOUR PROFITABILITY  
DEPENDS ON YOUR ABILITY  
TO TAKE THE RIGHT DECISIONS

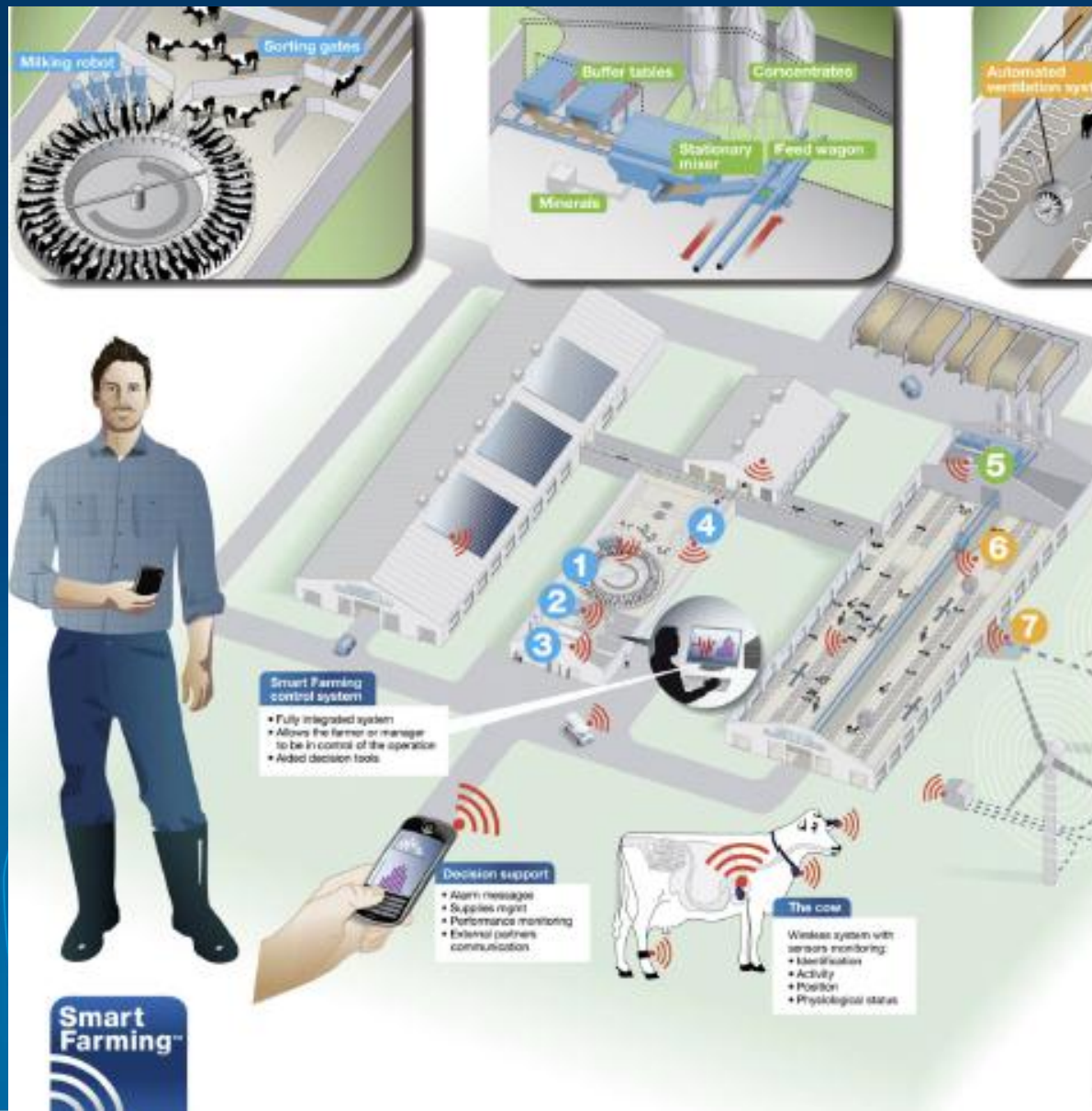



# DeLaval

## Fantastic Farmer Days

- Tijdens de Fantastic Farmer Days zal DeLaval:
  - Bedrijfsrondleiding verzorgen (station-programma)
  - Uitleg geven over slimme innovaties rondom melkvee-management (station-programma)
  - De nieuwste melkrobot VMS tonen (VMS – VMS supra – VMS supra+)





# Fantastic Farmer Days

BENELUX

Andrew Mabin  
Sales and Marketing Director

Contains confidential proprietary and trade secrets information of CNH Industrial. Any use of this work without express written consent is strictly prohibited.



**Mitas**

*Fit for your job*



# Mitas – leading agricultural tyre manufacturer

Andrew Mabin, sales and marketing director

April, 2014

## January 1933 – When Mitas' story began ....

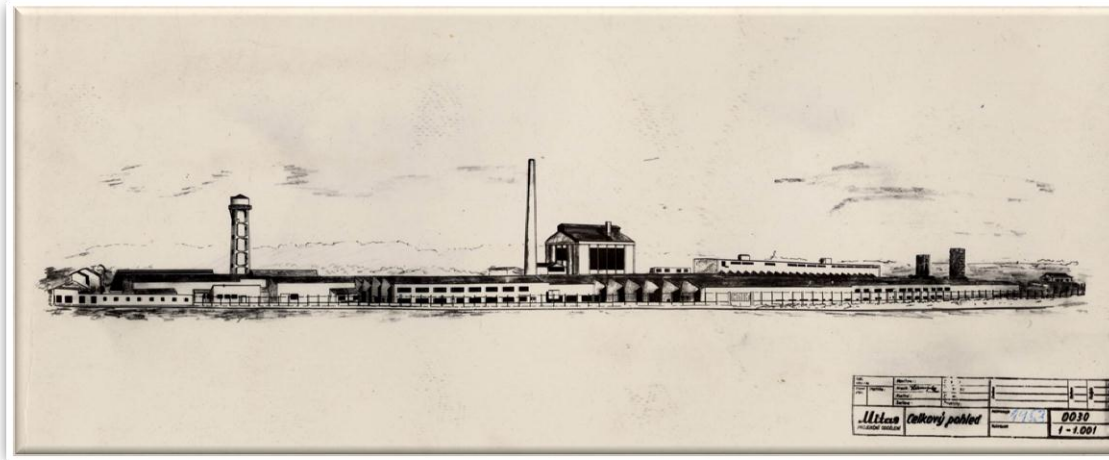



Mitas

*Fit for your job*

Mitas manufactures and sells tyres under three brand names, globally



SFT HC 2000 HC 1000 Agriterra 02 CR-01 ERL-50 ERD-40



SST SVT AC85 HC70 AC65









Radial-70 Radial-S AS-Agri AS-Impl AW-Impl AS-Front





# Broad, modern product portfolio – for all applications

	Tractors	Self-propelled Sprayers	Combines, Harvesters		Trailers	
			Front	Rear	< 1400 mm OD (Grassland)	> 1400 mm OD (Tankers)
Application						
Specific Requirement.	High Torque	High Transport Capacity	High Cyclic Loads in Field	Compactness	High Transport Capacity	High Transport Capacity
	High Speeds	Limited Section Width	Cornering on Road	High Loads on Road	No damage of Grassland	Self-cleaning
			Legal Requirements			
Mitas Solution	SFT SST HC 2000	HC 1000 [VF]	CHO SFT HC 3000 [VF]	IMP SFT [VF]	AGRITERRA-02	AGRITERRA-03

# Mitas

*Fit for your job*



# Thank you



# Fantastic Farmer Days

BENELUX

Carl De Braeckeleeer  
Commercieel directeur DLV

Contains confidential proprietary and trade secrets information of CNH Industrial. Any use of this work without express written consent is strictly prohibited.



# Fantastic Farmers Days



22 april 2014

Carl De Braeckeleeer



- ONE-STOP adviesbureau voor de dynamische ondernemer
- Team van gepassioneerde medewerkers met een hart voor landbouw
- Hands-on, pragmatische aanpak met kennis van de praktijk



DLV is voor zijn klanten dé partner die zorgt voor:

**De snelste weg van een bedreiging naar een kans**

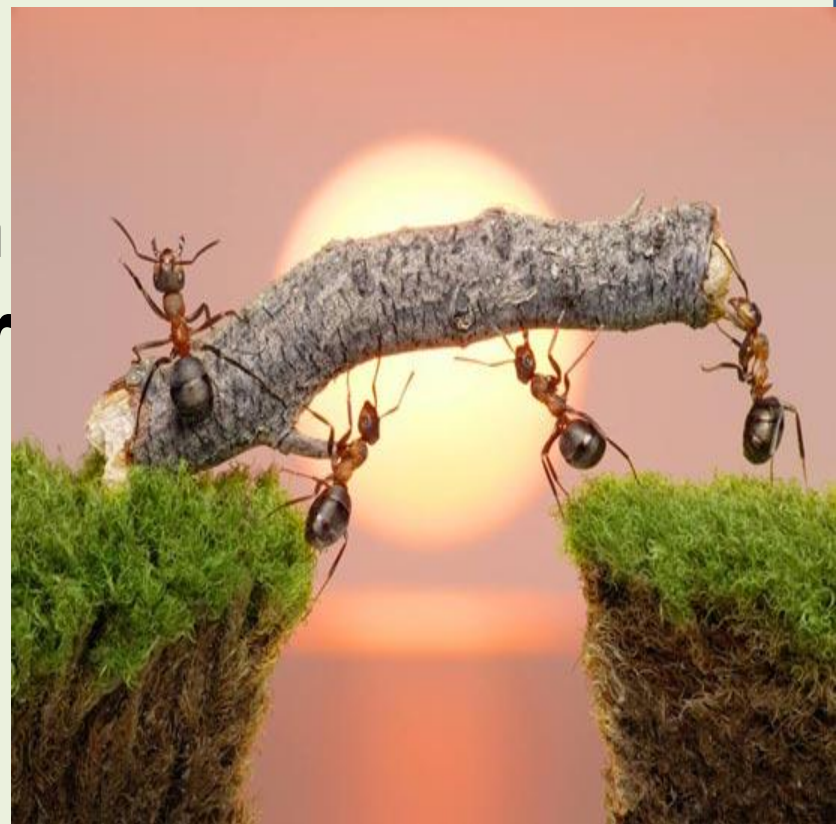

# *Bedreigingen?*

- Bedrijf uitbreiden of optimaliseren post quotum
- Nieuwe milieuverplichtingen
- Nieuwe bouwverplichtingen
- Van milieu- en bouwvergunning naar omgevingsvergunning
- Volatile markten voor grondstoffen en eindproducten
- Stijgende energieprijzen
- Nieuwe eisen van klanten en afnemers

- Ken uw kritische melkprijs en uw limiterende factoren !
- Milieuopvolging op maat biedt antwoord aan permanente vergunning
- Kostenbewust bouwen en bouwen met behoud van kwaliteit
- Bewuster omgaan met energie, het kan !
- Kwaliteits- en managementsystemen op maat bieden een concurrentieel voordeel

*It's up to u !*

- Vergunningen
- NER's
- Stallenbouw
- ...





• [www.dlv.be](http://www.dlv.be)



[info@dlv.be](mailto:info@dlv.be)



0800/90 910



0495/29 25 30





# Fantastic Farmer Days

BENELUX

Lode Vande Vyvere  
Marketing Manager

Contains confidential proprietary and trade secrets information of CNH Industrial. Any use of this work without express written consent is strictly prohibited.





# New Holland: 8 workshops van max. 20 min:

T4 Powerstar en TD5

T4 en T5 met voorlader

T6 met voorlader

T7SWB en T7LWB

T8

LM6.28 en 6.35 Elite

Persen

RTK(AGR/intellisteer) + praktische sessie

# New Holland workshops



# Alles over GPS besturingsystemen



# Wie is welkom op de Fantastic Farmer Days door?

---

- Iedereen die zich geregistreerd heeft op:
  - [www.fantasticfarmerdays.be](http://www.fantasticfarmerdays.be)
  - [www.fantasticfarmerdays.lu](http://www.fantasticfarmerdays.lu)
  - [www.fantasticfarmerdays.nl](http://www.fantasticfarmerdays.nl)



# Uitnodiging

- 30.000 melkveehouders worden persoonlijk uitgenodigd.
- Via dealers en klanten:
  - New Holland
  - Delaval
  - Mitas
  - DLV
- Filmpje met bekendmaking:
  - Facebook
  - Youtube
  - Trekkerweb
  - Andere
- Last but not least:
  - Vakpers

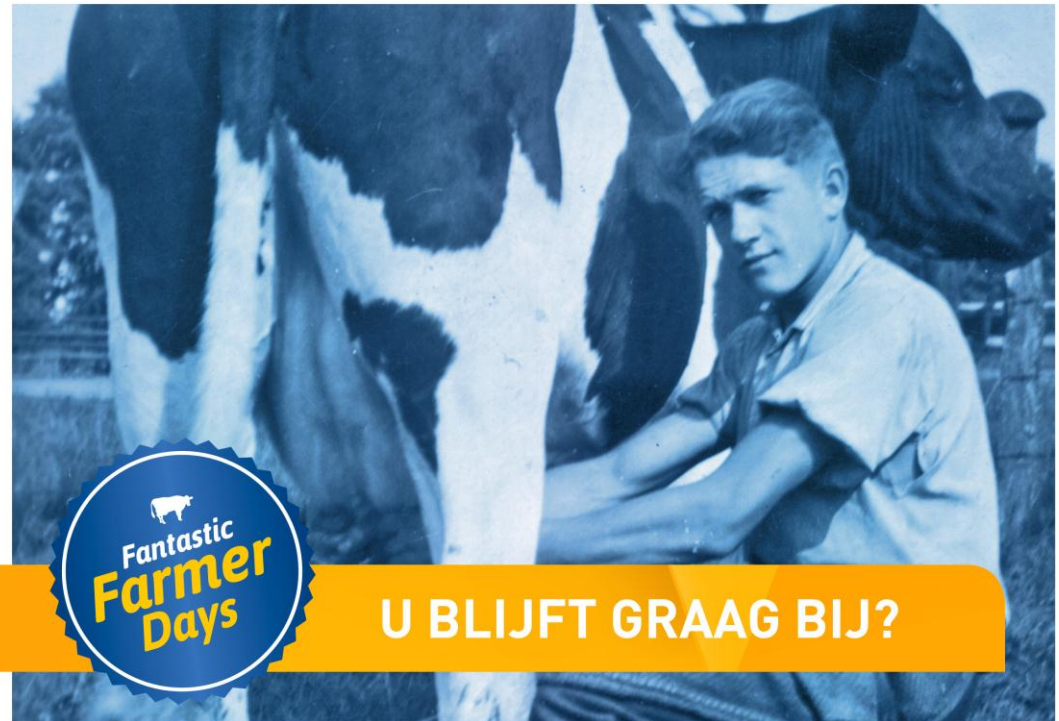



## Programma Fantastic Farmer Days

- 10u00: Aanvang
- 10u30: Presentaties: uitleg van alle nieuwe New Holland tractoren en persen, Stoll voorleiders, DeLaval melkmachines en Mitas banden
- 12u00: BBQ & dessert + drank (wordt u gratis aangeboden na vertoon voucher)
- 13u00: Keuzepakket om 6 workshops mee te volgen over New Holland, DeLaval, Mitas, DLV, CNH Parts & CNH Capital en een bezoek aan het melkveebedrijf met de DeLaval melkmachine in werking
- 16u00: Koffie en gebak
- 16u30: Einde voorzien

## Kijk op de gewenste locatie om u te registreren







## Fantastic Farmer Days Registratieformulier



 Ik zal aanwezig zijn op woensdag 28 mei in Zaffelare (Lochristi)

Bedrijf *	<input type="text" value="New Holland"/>	
Naam en voornaam *	<input type="text" value="Vande Vyvere"/>	<input type="text" value="Lode"/>
Naam en voornaam 2e persoon	<input type="text"/>	<input type="text"/>
Straat en nummer *	<input type="text" value="Leon Claeysstraat"/>	<input type="text" value="3A"/>
Postcode en gemeente *	<input type="text" value="8210"/>	<input type="text" value="Zedelgem"/>
Land *	<input type="text" value="België"/>	
Telefoon *	<input type="text" value="0496196617"/>	
Emailadres *	<input type="text" value="lode.vandevyvere@newholland.c"/>	

\* verplichte velden



## Fantastic Farmer Days Registratieformulier



### 📍 Bedankt voor uw inschrijving

Print deze voucher af en breng deze mee naar de Fantastic Farmer Day (gratis BBQ en geschenk).

Bedrijf	New Holland
Naam en voornaam	Vande Vyvere Lode
Naam en voornaam 2e persoon	
Straat en nummer	Leon Claeysstraat 3A
Postcode en gemeente	8210 Zedelgem
Land	België
Telefoon	0498198617
E-mailadres	lode.vandevyvere@newholland.com
Locatie	Koedreef 19 9080 Zaffelare (Lochristi)
Tijdstip	woensdag 28 mei van 10u00 tot 15u30

De voucher afdrukken

*Dit formulier dient als toegangsbewijs tot de Fantastic Farmer Days waardoor u ook kunt genieten van gratis barbecue en drank.*



## Fantastic Farmer Days - Voucher

<b>Bedrijf</b>	New Holland
<b>Naam en voornaam</b>	Vande Vyvere Lode
<b>Naam en voornaam 2e persoon</b>	
<b>Straat en nummer</b>	Leon Claeysstraat 3A
<b>Postcode en gemeente</b>	8210 Zedelgem
<b>Land</b>	België
<b>Telefoon</b>	0496196617
<b>E-mailadres</b>	lode.vandevyvere@newholland.com
<b>Locatie</b>	Koedreef 19 9080 Zaffelare (Lochristi)
<b>Tijdstip</b>	woensdag 28 mei van 10u00 tot 15u30

*Deze voucher dient als toegangsbewijs tot de Fantastic Farmer Days waardoor u ook kunt genieten van gratis barbecue en drank.*



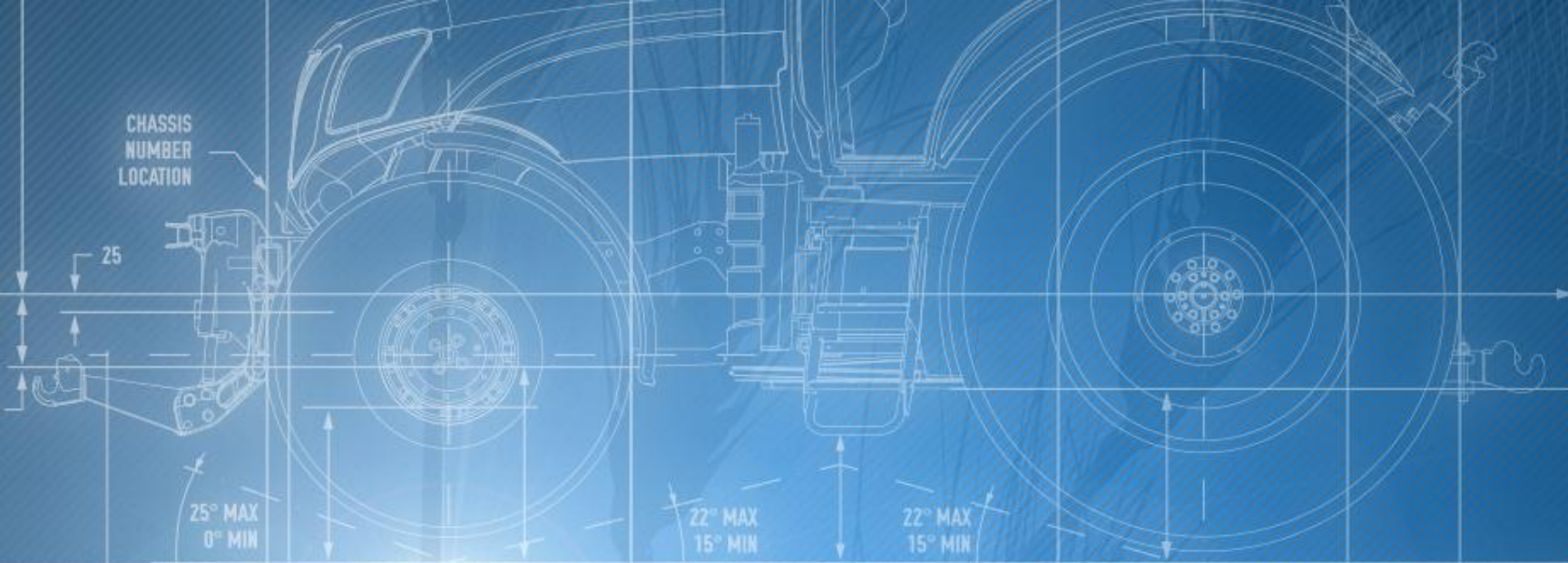

# Q&A





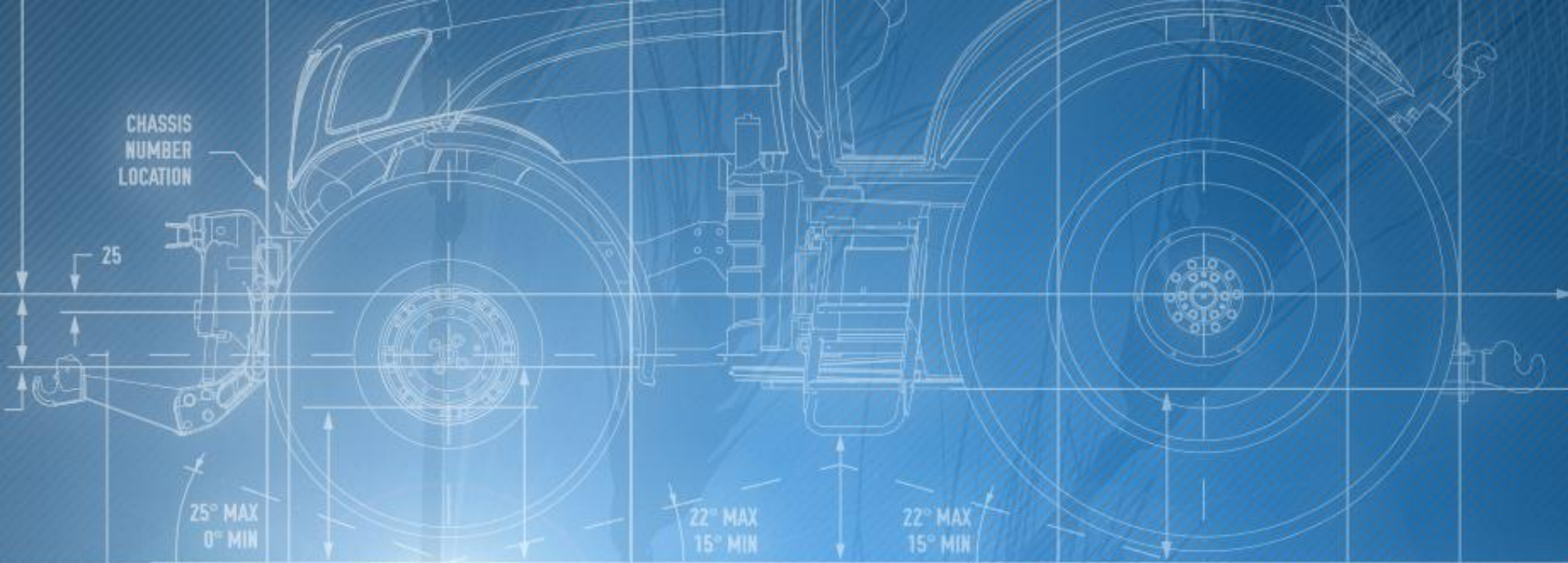

**Dank voor uw aandacht en  
tot ziens op een van de  
Fantastic Farmer Days!**

